

FEATURED MODEL

440300 Large, 12" bowl depth

ADDITIONAL MODELS

440298 Large, 8" bowl depth

440302 Large, 10" bowl depth

FEATURES

- Required outside cabinet: 33"
- 18 gauge, 304 series stainless steel
- Premium 18/8 chrome/nickel content
- Satin finish
- 4 diagonal drain grooves channel water directly to center drain
- Sound deadening insulation

OPTIONAL ACCESSORIES

Stainless Steel Sink Grid: 220997

CODE/STANDARDS COMPLIANCE

ASME 112.19.3-00

IAPMO/UPC listed

WARRANTY

Blanco America's Stainless Steel sinks feature a LIMITED LIFETIME WARRANTY to be free of all manufacturing defects under normal use. See our complete warranty for details.

While Blanco America endeavors to provide accurate information, all dimensions are nominal, cannot be guaranteed, and are subject to change or cancellation. Blanco America assumes no responsibility for use of superseded or voided specifications.

JOB INFORMATION

Job Name: _____

Contact: _____

Date Specified: _____

Specifier: _____

Contractor: _____



NOMINAL DIMENSIONS

Model 440300 shown

OVERALL	BOWL DEPTH	DRAIN
31-1/4" x 18"	12"	3-1/2"

DXF cutout templates available on our website.

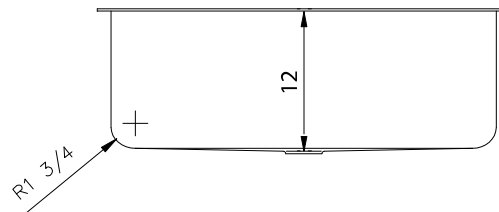
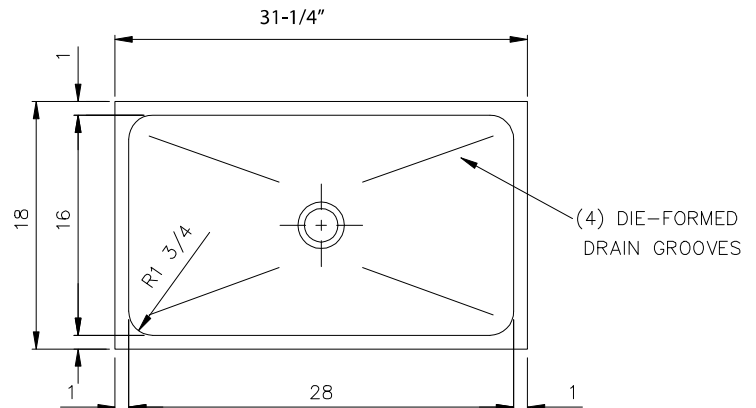

BLANCO AMERICA

800.451.5782

www.blancoamerica.com

© 2013 BLANCO AMERICA

6/13

SPEC-003